



Fusing Convolutional Neural Networks to Improve the Accuracy of Plant Leaf Disease Classification

Bhavana Nerkar^{1*} and Sanjay Talbar²

¹NIELIT Aurangabad, India.

²Department of E&TC Engineering, Shri Guru Gobind Singhji Institute of Engineering,
Nanded, India.

Authors' contributions

This work was carried out in collaboration between both authors. Author BN managed the literature searches, designed the study, performed the statistical analysis and wrote the protocol. Author ST designed the methodology, managed the analyses of the study. Both authors read and approved the final manuscript.

Article Information

DOI: 10.9734/CJAST/2020/v39i3931099

Editor(s):

(1) Dr. Chien-Jen Wang, National University of Tainan, Taiwan.

Reviewers:

(1) Faiq M. S. Al-Zwainy, Al-Nahrain University, Iraq.

(2) Hazem Esmaeel Radhi, University of Thi-Qar, Iraq.

Complete Peer review History: <http://www.sdiarticle4.com/review-history/63016>

Original Research Article

Received 10 October 2020

Accepted 24 November 2020

Published 12 December 2020

ABSTRACT

Aims: This text aims to improve the accuracy of plant leaf disease detection using a fused convolutional neural network architecture

Study Design: In this study, propose a hybrid CNN architecture, that adds a bio-inspired layer to the existing CNN architecture in order to improve the accuracy and reduce the delay needed for leaf disease classification.

Place and Duration of Study: National institute of electronics and information technology Aurangabad, between June 2018 and September 2020.

Methodology: Convolutional neural networks (CNNs) have become a de-facto technique for classification of multi-dimensional data. Activation functions like rectified linear unit (ReLU), softmax, sigmoid, etc. have proven to be highly effective when doing so. Moreover, standard CNN architectures like AlexNet, VGGNet, Google net, etc. further assist this process by providing standard and highly effective network layer arrangements. But these architectures are limited by the speed due to high number of calculations needed to train and test the network. Moreover, as the number of classes increase, there is a reduction in validation and testing accuracy for the networks.

*Corresponding author: E-mail: bhavananerkar7@gmail.com;

In order to remove these drawbacks, hybrid CNN architecture, that adds a bio-inspired layer to the existing CNN architecture in order to improve the accuracy and speed of leaf classification.

Results: The developed system was tested on different kinds of leaf diseases, and it was observed that the proposed system obtains more than 98% accuracy for both testing and validation sets.

Conclusion: It is observed that the delay is reduced, while the accuracy is improved by the most effective classifiers. This encourage us to use the proposed system for real-time leaf image disease detection.

Keywords: Image; leaf; disease; convolutional; neural; bio-inspired; hybrid.

1. INTRODUCTION

Convolutional neural networks take into consideration a large number of features in order to classify image data into different classes. These features are evaluated using features masks, which include, but are not limited to,

- Horizontal feature mask
- Vertical feature mask
- Diagonal feature mask
- Color feature mask
- Edge feature mask, and many more

These masks work in different strides. Each stride covers a particular part of the image, and is selected such that there is limited over-sampling and maximum feature coverage. The following Fig. 1 indicates the feature coverage of CNNs. Which indicates that even the simplest of CNNs have a large number of features for comparison. Moreover, each of the feature maps is cascaded with other feature maps in order to increase the number of final features for classification. The classification process combines multiple neural nets in order to obtain the final class. The combination requires different

layers to be connected in a manner that achieves higher accuracy. Standard architectures like AlexNet, VGGNet, GoogLeNet, etc. have been proposed for the same.

The Fig. 2 indicates the architecture of Google Net which was proposed by Google for CNN-based classification systems.

Using these architectures leaf images can be classified into different diseases. In this paper, we have used a standard VGGNet architecture and combined it with a self-designed bio-inspired layer. This not only improves the accuracy of VGGNet, but also increases the speed of operation of the overall system. The design details for the proposed system is described in section 3 of this paper. The next section describes works done by different researchers over the years in leaf image disease classification, followed by the proposed network design, and finally we conclude this text with some interesting observations about the proposed system, and future research that can be done for further checking the system performance.

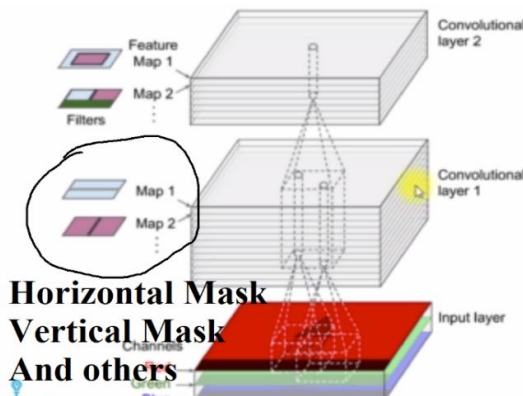

Fig. 1. CNN feature maps

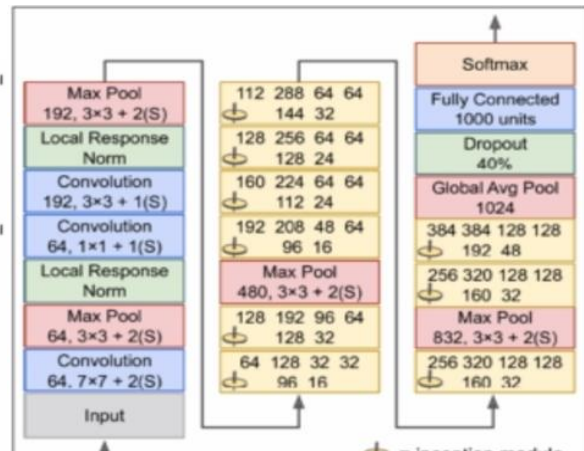

Fig. 2. Google net CNN architecture

2. LITERATURE REVIEW

Research done in leaf disease detection using image processing has shifted from general classifiers like k-Nearest neighbours (kNN), support vector machines (SVM), etc. to more complex and performance aware algorithms like convolutional neural networks, Q-learning, etc. Like the work done in [1], wherein researchers have used convolutional neural networks in order to boost the testing set accuracy from less than 80% to more than 98%. They have used the AlexNet and GoogleNet based CNN models in order to perform this task. The number of images used by these researchers is limited, and thus it is recommended that readers should use larger number of images and evaluate the system's performance. The work proposed by them [1] is based on Soybean leaf diseases, but can be extended to any kind of leaf. In contrast to [1], the work done in [2] uses local binary patterns and combines it with SVM for classification. They have evaluated Bacterial Blight, Cercospora Leaf Spot, Powdery Mildew and Rust diseases in the leaf. They have claimed to achieve a training set accuracy of more than 98%, but there is no comment on the test set accuracy, which is generally 8% to 15% less than the training set accuracy for linear classifiers like SVM, thus the accuracy [2] can be considered to a little above 90% (at most). But, this has to be again evaluated by researchers in order to check the overall system performance.

The work in [3] re-introduces a new flavour of neural networks named as fuzzy ARTMAP neural network. They have used the grey level co-occurrence matrix (GLCM) and combined it with the proposed neural network-based classifier in order to get an improved accuracy. Their training set accuracy is more than 95%, while the test set accuracy is around 90%. Coming back to CNNs, the work in [4] works on maize leaf diseases from the PlantVillage dataset. Their architecture combines the principal component analysis (PCA) with the LeNet CNN architecture to obtain an accuracy of 97%, which is a huge improvement over other network architecture. This can be used as a de-facto standard for processing leaf images, and can be further improved upon. Another model of CNN that uses LeNet is described in [5], wherein researchers have used the similar processing layers like [4] and obtained 91% testing set accuracy for tomato leaf diseases. This helps us in further finalizing CNNs as the network of choice for our research. CNN has different network

architectures which must be evaluated before finalizing the one suited for our application. For instance, the work in [6] uses the ResNet architecture for identifying Soybean leaf diseases. Due to the usage of ResNet the overall system accuracy enhances to 94%, it is tested across 27 different kind of CNN models. The proposed ResNet model is found to be better than GoogLeNet and AlexNet models when applied to leaf disease detection.

Simpler CNN models that use multiple softmax layers also outperform complex non-CNN algorithms like local binary patterns histograms (LBPH) and Haar-WT (Wavelet Transform) in terms of valid feature extraction as seen in [7], wherein multiple softmax layers in CNN are used. The work proposes that the testing accuracy of classification is more than 95%, whereas techniques like SVM and LBP based methods can reach only upto 85%. But, using complex models like AlexNet, GoogleNet and DenseNet201 have their own distinct advantages for leaf disease detection. The work in [8] verified this point by applying the AlexNet, GoogleNet and DenseNet201 architectures for apple leaf disease detection. The algorithm with these combined architectures is able to achieve an accuracy of 99% on a moderate sized dataset. But the delay of training is very huge, from our research it should take more than 4 days for training such a complex model. Adding multiple CNN layers is not advisable, because it adds to the design complexity, and reduces the accuracy to device utilization ratio. Such high accuracy can also be achieved with proper feature selection and using a simple flat layered neural network. Such a work is done in [9], wherein statistical attributes and local binary patterns were extracted and given to a neural network classifier. This work reduced the training delay to less than an hour, while obtaining a high accuracy of 98%. Such simpler alternative approaches must be used in order to improve the system's efficiency, rather than using multi-layer CNNs, that consume many computational cycles, and results in a high accuracy for a moderately sized dataset. Intelligent approaches like the one used in [10] can be considered for further improving the system's efficiency. The researchers have used GoogLeNet Inception structure and Rainbow concatenation for designing their CNN. Using these layers, the overall accuracy of classification for Apple leaf diseases has gone upto 97% with a large input size of more than one million records. Selecting CNNs as the choice of research becomes

inherently clear when the work in [11] is reviewed. SVM and other linear methods are limited by their feature processing layer, this is where CNN architectures come into play. A similar review is done in [12], wherein they have also mentioned that CNNs are the choice of selection for any kind of leaf disease classification application. This is further verified by [13], wherein a real time system is developed using CNN for classification of plant leaf diseases, and an accuracy of more than 95% is achieved.

Bio inspired methods are another set of algorithms which can further improve the accuracy of CNNs. This can be seen from [14], wherein a review of various bio-inspired methods is done so that the best algorithm(s) can be identified. It is seen that Genetic Algorithm is the best performing algorithm for finding out the best features from leaf images. We have also used a Genetic Algorithm inspired technique to optimize the performance of our CNN. A study on different leaf diseases detection using CNN is proposed in [15] which also indicates that CNN-based classifiers can achieve more than 95% accuracy for classification. Thus, our work is a combination of CNN and bio-inspired methods for classification of plant diseases.

3 METHODOLOGY

3.1 Proposed Fused Convolutional Neural Network Design

The proposed hybrid machine learning based CNN algorithm used to detect plant diseases from images. To take images of diseased leaf the good resolution mobile camera with Samsung Exynos 7 Octa 7580 processor ,13mp camera as well as DSLR is used and to take results HP 1000tx laptop is used with latest version of software. this works in two phases,

- Intensive + Incremental learning phase
- CNN evaluation phase

The first phase for incremental and intensive learning works using the following steps,

- i. Initially the incremental learning parameters are initialized,
 Nr = Number of iterations or rounds
 Ns = Number of different solutions used for learning
 Lr = Machine learning factor, or speed up factor
 Fmax = Number of maximum features to be used per solution

- Cmax = Number of maximum classifiers to be used for each solution
 Imax = Maximum number of training images to be used per solution
- ii. For each round, for each solution which has improper learning values perform the following,
 - a. Select random but class-known frames from the image sequence. Select the number of frames to be Imax
 - b. Find the values of key points for all these Imax images
 - c. Find out the best matching Fmax key points, which will be the maximum features
 - d. The key points are selected using maximum distance between each other. This ensures that each of the key points are distinctly distanced from each other, thereby ensuring better feature extraction
 - e. Use random classifiers from the following classifiers, make sure that the selected classifiers are maximum Cmax in number,
 - i. k-nearest neighbours (kNN) [16]
 - ii. Support vector machine (SVM) [17]
 - iii. Neural network with different layer configurations (NN) [18]
 - iv. Quadratic linear classifier (QL) [19]
 - v. Mahalanobis classifier (MH) [20]
 - vi. Random forest classifier (RF) [21]
 - vii. Naïve Bayes classifier (NB) [22]
 - f. Perform training and evaluation of these classifiers for the Imax number of images, and with Fmax features
 - g. Find the value of accuracy for the given classifier set, and mark it as the learning convergence for this solution, using the following formula,

$$Lc = \frac{\sum_{i=1}^{I_{max}} A_i / N_{di}}{I_{max}} \dots \quad (1)$$

A_i = Accuracy for i^{th} image
 N_{di} = Normalized Delay needed for processing the i^{th} image

- h. Evaluate the value of normalized delay using the following formula,

$$N_{di} = \frac{d_i}{\sum d_i} \dots \quad (2)$$

where, d_i = delay needed to process the i^{th} image

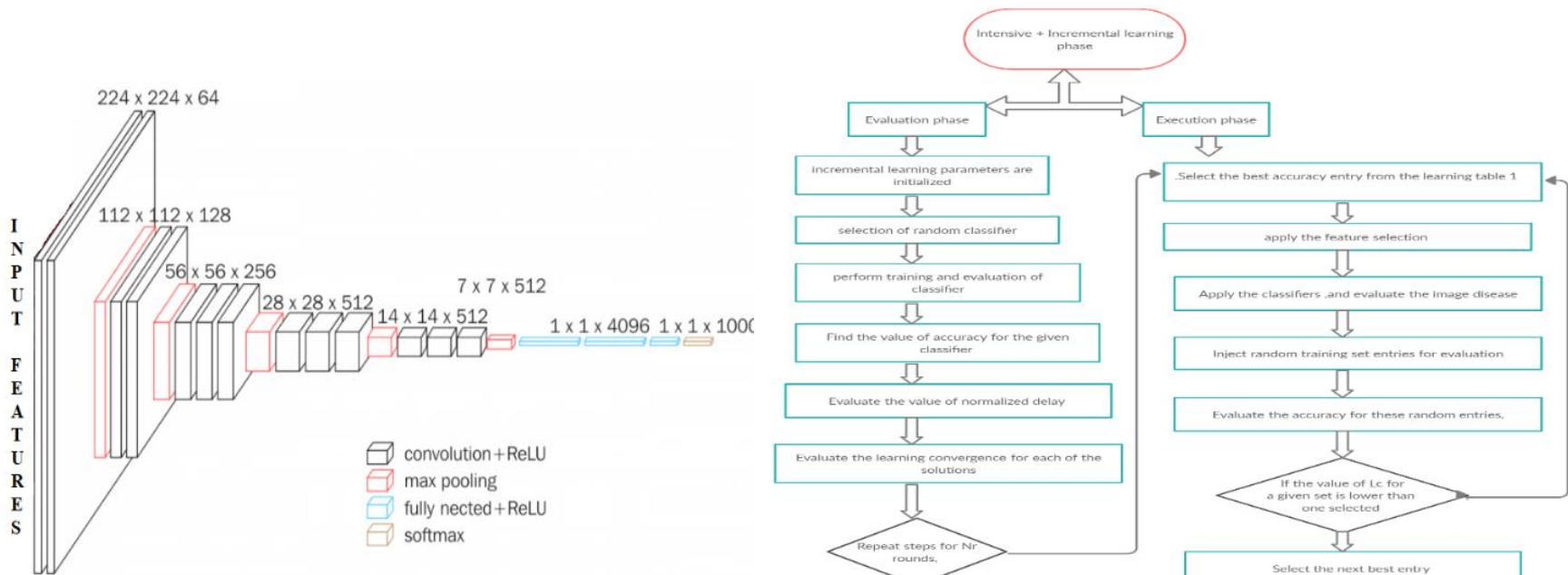

Fig. 3. The VGG net model [23-25] with the flowchart of the system

- i. Store the solution into a list for future reference
- ii. Evaluate the learning convergence for each of the solutions, and then evaluate the learning threshold

$$Lth = \frac{\sum_{i=1}^{Ns} LCi}{Ns} * Lr \quad (3)$$

where, Lr is the learning rate

- iii. Pass all the solutions to the next round that satisfy equation number 4, else remove the solutions and replace them with new ones (ii)

$$LCi > Lth \dots \quad (4)$$

- iv. Repeat steps (ii) to (iv) for Nr rounds, and prepare the following table at the end of the Nr round,

Table 1. The intensive learning-table

Sol. Num	Sel. CFs	Selected KPs	LC val	Accuracy (%)
----------	----------	--------------	--------	--------------

- v. From the Table 1, select the solution with highest value of LC and highest value of accuracy and use it for the execution phase. In the table, CF stands for classifier, KP stands for key points

Due to the intensive learning phase, we get a large number of solutions, which are kept for further evaluation in the actual execution phase. The following steps are performed in the actual execution phase,

- i. Select the best accuracy entry from the learning Table 1
- ii. For each of the input frame in the image, apply the feature selection as mentioned in the 3rd column
- iii. Apply the classifiers as mentioned in the 2nd column of Table 1, and evaluate the image disease
- iv. Inject random training set entries for evaluation, and repeat steps (i) to (iii) for these random entries
- v. Evaluate the accuracy for these random entries, and evaluate the value of Lc for each of these entry sets
- vi. If the value of Lc for a given set is lower than the one selected from Table 1, then update Table 1 with this value

- vii. Select the next best entry from Table 1, and repeat the process for each of the frames
- viii. In case more than half of the entries of Table 1 are replaced, then retrain the algorithm with the help of the pre-execution step, and re-create Table 1 with better entries of Lc

Once the system gives the result about the disease present in the image, then the selected features from the sequence are given to the VGGNet CNN model. The VGGNet model can be shown in Fig. 3.

The input image features are given to a 64-mask set unit, that evaluates 64 different feature masks from the input features. These feature masks include horizontal, vertical, diagonal, and other components. Each of these features is then given different ReLU based layers, where feature optimization is done, and finally the input features are classified into one of N classes. This addition of the ML layer to the VGG net model helps in reducing the training delay, and thereby improves the overall performance of the CNN. The result and evaluation of the proposed model is performed in the next section.

4. RESULTS AND OBSERVATIONS





We compared the performance of the proposed model using custom collected datasets. A training: testing: validation ratio of 7:2:1 was used while performing the evaluation. Different CNN architectures were compared, and the final performance evaluation is done. Different kinds of images were used for this purpose. The details about these diseases, and the number of images used for each disease can be observed from the Table 2.

From the results it is evident that the accuracy of the proposed method outperforms other methods. But our method also outperforms other CNN implementations w.r.t. the speed of operation. This can be observed from the above Table 4.

The reduction in delay is due to the pre-processing done during the machine learning phase. Due to the pre-processing the number of feature sets needed for classification reduce drastically which reduces the overall training and evaluation delays. Of course, there is a delay in feature extraction, but that is infinitesimal when

compared to the final delay of evaluation for the help of the delay and accuracy graphs as shown networks. The results can be observed with the in the Figs. 4 and 5.

Table 2. Number of images with type of diseases

SN	Disease name	Information	Sample image
1	Bacterial blight	It is one of the destructive diseases affecting cotton crop having blackish colour of vein and spots. Number of images used for evaluation: 976	
2	Reddening	It occurs since cotton was introduced in India The red pigment in the leaves generally. Number of images used for evaluation: 895	
3	Alternaria	Producing brownish numerous leaf spots. Number of images used for evaluation: 1157	
4	Grey mildew	White angular spots on both sides of the leaves occurs. Number of images used for evaluation: 946	

Each of these disease images is divided into the same 7:2:1 ratio for training, testing and validation. The results on a combined dataset for different algorithms can be seen from Table 3

Table 3. Accuracy of different classifiers tested

Img tested	Acc()% DWT+LBP[2]	Acc(%) NN with Cpix[3]	Acc(%) RCNN [4]	Acc(%) Bio-CNN[7]	Acc(%)multi CNN [8]	Acc(%) Proposed CNN
10	90.00	90.00	100.00	100.00	100.00	100.00
25	95.00	93.00	95.00	100.00	100.00	100.00
40	95.20	96.00	96.80	97.10	100.00	100.00
50	95.60	96.50	97.30	97.60	98.60	100.00
75	95.60	96.70	97.60	97.80	98.70	100.00
100	95.70	96.80	97.80	97.90	98.70	99.30
200	95.70	96.70	97.90	98.10	98.80	98.90
500	95.70	96.80	97.90	98.20	98.80	99.40

Table 4. Delay v/s number of images

Img tested	Delay(ms) DWT+ LBP[2]	Delay(ms) NN with cpix [3]	Delay(ms) RCNN [4]	Delay (ms) Bio-CNN [7]	Delay(ms) Multi CNN [8]	Delay (ms) Proposed CNN
10	2.36	6.90	8.42	5.52	11.60	1.24
25	2.87	7.60	9.52	6.25	13.25	1.51
40	3.69	7.90	10.54	6.91	14.52	1.94
50	5.98	12.90	17.16	11.26	23.65	3.15
75	5.99	18.20	21.99	14.43	30.31	3.15
100	6.98	35.75	38.80	25.46	53.47	3.67
200	7.59	72.60	72.90	47.84	100.47	3.99
500	8.60	125.20	121.64	79.82	167.63	4.53

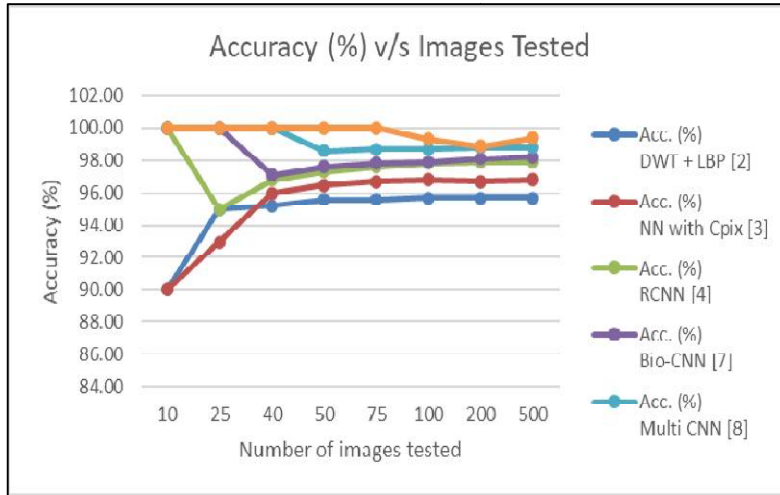

Fig. 4. Comparison of Accuracy of different algorithms

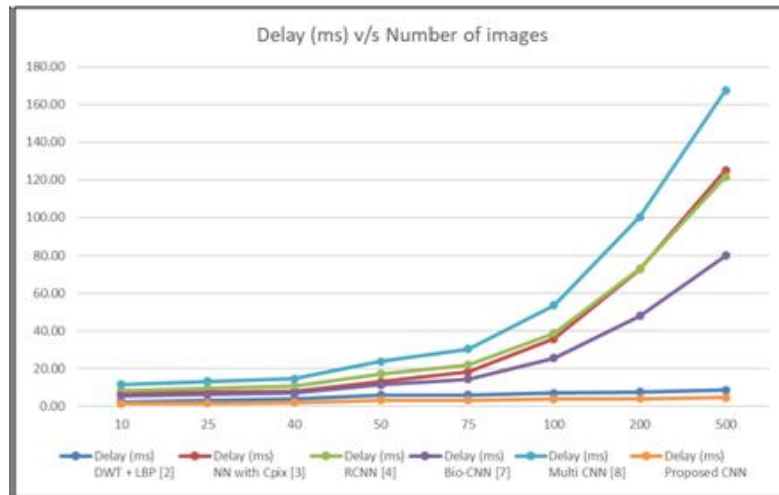

Fig. 5. Delay comparison of the proposed CNN

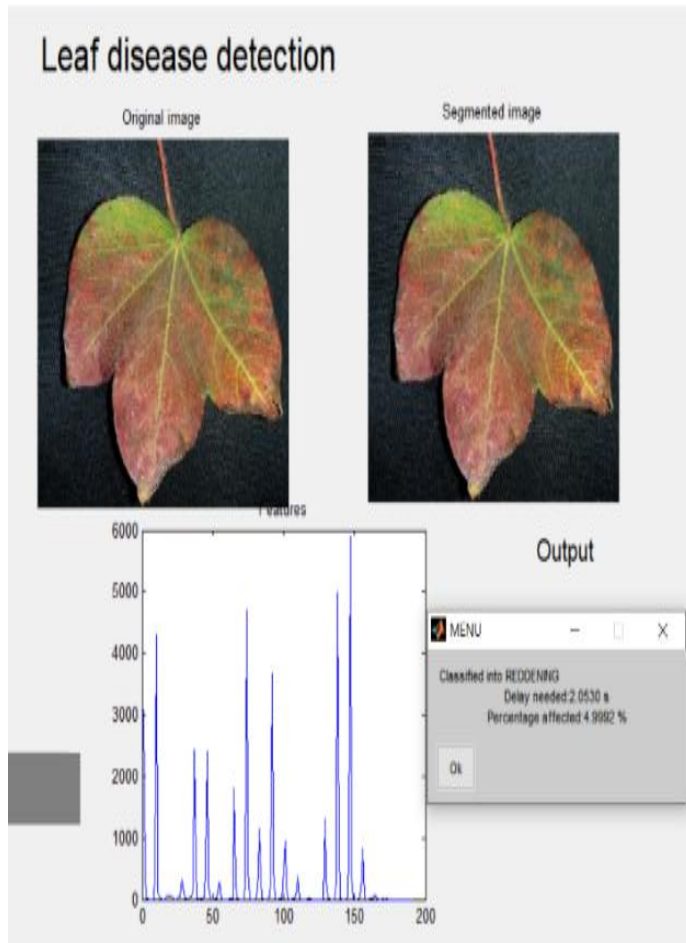

Fig. 6. Disease image

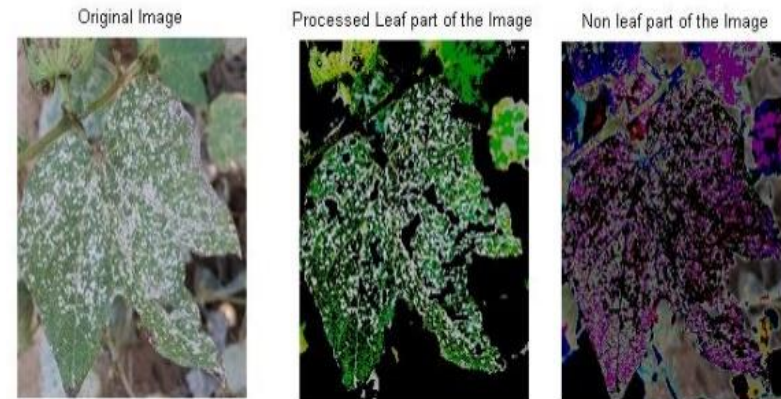

Fig. 7. Disease image processing sequence

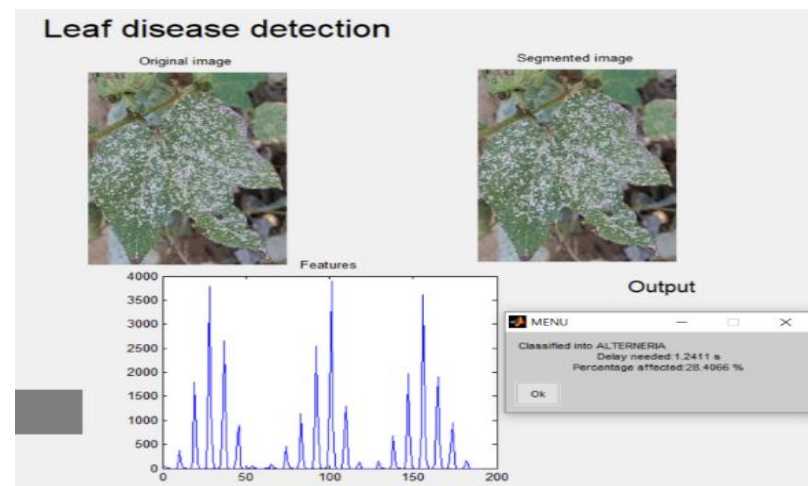

Fig. 8. Alternaria disease image

From Fig. 4 it is seen that there is a tough competition in this domain, as CNN performs considerably well, but the delay graph shown in Fig. 5 showcases the superiority of the proposed technique,

We developed the proposed system using Python 3.5 using the Tensor Flow and Keras libraries, and tested the same on the image datasets. The results from the proposed systems can be showcased in the Figs. 6, 7 and 8. It is clear from these figures that the system is able to quickly and effectively identify the number of disease image sequences from the set of input images. Thus, it can be used for real-time scenarios where both speed and accuracy constraints are to be satisfied.

From these results we can observe that the developed system has high accuracy, and low delay of operation and thereby can be used in any kind of leaf image disease detection system.

Results should be clearly described in a concise manner. Results for different parameters should be described under subheadings or in separate paragraph. Table or figure numbers should be mentioned in parentheses for better understanding.

5. CONCLUSION

The results indicate that the delay and accuracy have both been optimized by the proposed classifier. In order to showcase the improvement in both delay and accuracy, it can observe the Table 4, wherein a comparison of mean delay and mean accuracy over different image frames is done, and it is seen that the delay is reduced by more than 40%, while the accuracy is improved by more than 5% than the most effective classifiers. These results encourage us to use the proposed system for real-time leaf image disease detection. In future, GAN-based networks can be integrated with the proposed system in order to further improve its performance.

COMPETING INTERESTS

Authors have declared that no competing interests exist.

REFERENCES

1. Jadhav S, Udipi V, Patil S. Identification of plant diseases using convolutional neural

- networks. International Journal of Information Technology; 2020.
2. Oo Y, Htun N. Plant leaf disease detection and classification using image processing. International Journal of Research and Engineering. 2018;5(9): 516-523.
3. Khitthuk C. Plant leaf disease diagnosis from color imagery using co-occurrence matrix and artificial intelligence system. IEECON. 2018;4.
4. Ahila Priyadarshini R, Arivazhagan S, Arun M, Mirnalini A. Maize leaf disease classification using deep convolutional neural networks. Neural Computing and Applications. 2019;31.
5. TM P, Pranathi A, Sai Ashritha, K. Tomato leaf disease detection using convolutional neural networks. Proceedings of 2018 Eleventh International Conference on Contemporary Computing (IC3). 2018;5.
6. Wu Q, Zhang K, Meng J. Identification of soybean leaf diseases via deep learning. Journal of The Institution of Engineers (India): Series A. 2019;100(4): 659-666.
7. Liang W, Zhang H, Zhang G, Cao H. Rice blast disease recognition using a deep convolutional neural network. Scientific Reports. 2019;9(1).
8. Turkoglu M, Hanbay D, Sengur A. Multi-model LSTM-based convolutional neural networks for detection of apple diseases and pests. Journal of Ambient Intelligence and Humanized Computing; 2019.
9. Boa Sorte L, Ferraz C, Fambrini F, Goulart R, Saito J. Coffee leaf disease recognition based on deep learning and texture attributes. Procedia Computer Science. 2019;159:135-144.
10. Jiang P, Chen Y, Liu B, He D, Liang C. Real-time detection of apple leaf diseases using deep learning approach based on improved convolutional neural networks. IEEE Access. 2019;7.
11. Saranya S, Chandra Kiran N, Jyotheeswar Reddy K. Identification of diseases in plant parts using image processing. International Journal of Engineering & Technology. 2018;7(2.8):461.
12. kumar S, Raghavendra B. Diseases detection of various plant leaf using image processing techniques: A review. In: 5th International Conference on Advanced Computing & Communication Systems (ICACCS). 2019;5.

13. Nage M, Raut P. Detection and identification of plant leaf diseases based on python. *International Journal of Engineering Research & Technology (IJERT)*. 2019;8(5):5.
14. Singh V, Misra A. Detection of plant leaf diseases using image segmentation and soft computing techniques. *Information Processing in Agriculture*. 2017;4(1):41-49.
15. Mohanty S, Hughes D, Salathé M. Using deep learning for image-based plant disease detection. *Frontiers in Plant Science*. 2016;7.
16. sukhveer kaur,shreelekha pandey. Plant disease identification and classification through leaf images *Archives of Computational Methods in Engineering*; 2019.
17. Usama Mokhtar, Nashwa El-Bendary. SVM-based detection of tomato leaves diseases *springer international Publishing Switzerland*. 2015;641-652.
18. Md. Rasel Mia, Sujit Roy, Mango. leaf disease recognition using neural network and support vector machine. *Iran Journal of Computer Science* *springer*; 2020.
19. Muhammad Hammad Saleem. Johan Potgieter, plant disease detection and classification by deep learning; 2019. Available: www.mdpi.com/journal/plants
20. Priyadharshini MK, Sivakami R, Sooty. Mould mango disease identification using deep learning, *International Journal of Innovative Technology and Exploring Engineering (IJITEE)*. 2019;8(5S). ISSN: 2278-3075.
21. Gittaly Dhingra, Vinay Kumar. Study of digital image processing techniques for leaf disease detection and classification *Springer Science+ Business Media, LLC, part of Springer Nature*; 2017.
22. Konstantinos P. Ferentinos. Deep learning models for plant disease detection and diagnosis. *Computers and Electronics in Agriculture*. 2018;145 :311–318.
23. Ibraheem A. Aidan, Duaa Al-Jeznawi, Faiq MS, Al-Zwainy. Predicting earned value indexes in residential complexes' construction projects using artificial neural network model. *International Journal of Intelligent Engineering and Systems*. 2020; 13(4):248-259.
24. Zamim SK, Faraj NS, Aidan IA, Al-Zwainy FMS, Abdul Qader MA, Mohammed IA. Prediction of dust storms in construction projects using intelligent artificial neural network technology. *Periodicals of Engineering and Natural Sciences*; 2019. Available: <https://doi.org/10.21533/pen.v7i4.857>
25. Alzwainy FMS, Al-Suhaily RH, Saco ZM. Project management and artificial neural networks: Fundamental and application. *LAP LAMBERT Academic Publishing*; 2015.

© 2020 Nerkar and Talbar; This is an Open Access article distributed under the terms of the Creative Commons Attribution License (<http://creativecommons.org/licenses/by/4.0>), which permits unrestricted use, distribution, and reproduction in any medium, provided the original work is properly cited.

Peer-review history:
The peer review history for this paper can be accessed here:
<http://www.sdiarticle4.com/review-history/63016>